

# 조명타워 규격서

물품분류번호(39112001)

세부품명번호 (3911200101)

(철제 및 스테인리스에 한함)

2020. 11.

업체명 : (주)태 현

주소 : 경기 화성시 팔탄면 노하길 355-14

Tel : 031-354-5901, Fax : 031-354-5900

홈페이지 : <http://taehun.co.kr>

## 2 붙임

단위 mm

No	물품식별번호	모델명	모양 및 높이 (노풍도) 등기구 수	타워			상부 구조물			표면 처리	옵션/기타	주재료 공급자	원산지
				구분	재질	직경*두께*높이	형태	재질	치수 (가로*세로*높이)				
1	22546379	THP4-50312 12m, 6등용	고깔형 12m(C) 6등용	1단	ATOS60/ STKT590	200*350*4*12,000	사각형	SS400 또는 STK400 또는 SPSR400	2,400*900*1,000 이하	용융 아연 도금	스텝볼트, 앙카포함 안정기함, 투광등기구, 램프, 안정기, 분전함, 사다리, 안전보호망 별매	포스코	한국
2	22546380	THP4-50315 15m, 6등용	고깔형 15m(C) 6등용	1단	ATOS60/ STKT590	278*380*4*7,800	사각형	SS400 또는 STK400 또는 SPSR400	2,800*1,020*1,000 이하	용융 아연 도금	스텝볼트, 앙카포함 안정기함, 투광등기구, 램프, 안정기, 분전함, 사다리, 안전보호망 별매	포스코	한국
				2단		190*292*4*7,800							
3	22546381	THP4-50318 18m, 6등용	고깔형 18m(C) 6등용	1단	ATOS60/ STKT590	278*380*6*9,300	사각형	SS400 또는 STK400 또는 SPSR400	2,800*1,020*1,000 이하	용융 아연 도금	스텝볼트, 앙카포함 안정기함, 투광등기구, 램프, 안정기, 분전함, 사다리, 안전보호망 별매	포스코	한국
				2단		190*292*4*9,300							
4	22546382	THP4-50320 20m, 10등용	고깔형 20m(C) 10등용	1단	ATOS60/ STKT590	367*500*6*10,400	사각형	SS400 또는 STK400 또는 SPSR400	4,000*1,020*1,000 이하	용융 아연 도금	안전보호망, 앙카포함 안정기함, 투광등기구, 램프, 안정기, 분전함 별매	포스코	한국
				2단		250*384*4*10,400							
5	22546383	THP4-50325 25m, 10등용	고깔형 25m(C) 10등용	1단	ATOS60/ STKT590	488*600*6*8,900	사각형	SS400 또는 STK400 또는 SPSR400	4,000*1,020*1,000 이하	용융 아연 도금	안전보호망, 앙카포함 안정기함, 투광등기구, 램프, 안정기, 분전함 별매	포스코	한국
				2단		396*507*4*8,900							
				3단		300*412*4*8,900							

### 3 붙임

No	물품식별번호	모델명	모양 및 높이 (노풍도) 등기구 수	타워			상부 구조물			표면 처리	옵션/기타	주재료 공급자	원산지
				구분	재질	직경*두께*높이	형태	재질	치수 (가로*세로*높이)				
6	24076862	THP4-S50312 12m, 6등용	고깔형 12m(C) 6등용	1단	SS400	200*350*6*12,000	사각형	SS400 또는 STK400 또는 SPSR400	2,400*900*1,000 이하	용융 아연 도금	스텝볼트 포함 양카, 안정기함, 투광등기구, 램프, 안정기, 분전함, 사다리, 안전보호망 별매	포스코	한국
7	24076863	THP4-S50315 15m, 6등용	고깔형 15m(C) 6등용	1단	SS400	277*380*8*7,800	사각형	SS400 또는 STK400 또는 SPSR400	2,800*1,020*1,000 이하	용융 아연 도금	스텝볼트 포함 양카, 안정기함, 투광등기구, 램프, 안정기, 분전함, 사다리, 안전보호망 별매	포스코	한국
				2단		190*293*6*7,800							
8	24076864	THP4-S50318 18m, 6등용	고깔형 18m(C) 6등용	1단	SS400	276*380*9*9,300	사각형	SS400 또는 STK400 또는 SPSR400	2,800*1,020*1,000 이하	용융 아연 도금	스텝볼트 포함 양카, 안정기함, 투광등기구, 램프, 안정기, 분전함, 사다리, 안전보호망 별매	포스코	한국
				2단		190*294*6*9,300							
9	24076865	THP4-S50320 20m, 10등용	고깔형 20m(C) 10등용	1단	SS400	366*500*8*10,400	사각형	SS400 또는 STK400 또는 SPSR400	4,000*1,020*1,000 이하	용융 아연 도금	안전보호망 포함 양카, 안정기함, 투광등기구, 램프, 안정기, 분전함 별매	포스코	한국
				2단		250*386*6*10,400							
10	24076866	THP4-S50325 25m, 10등용	고깔형 25m(C) 10등용	1단	SS400	486*600*8*8,900	사각형	SS400 또는 STK400 또는 SPSR400	4,000*1,020*1,000 이하	용융 아연 도금	안전보호망 포함 양카, 안정기함, 투광등기구, 램프, 안정기, 분전함 별매	포스코	한국
				2단		395*509*6*8,900							
				3단		300*414*6*8,900							
11	24082253	THP4-SS50325 25m, 10등용	고깔형 25m(C) 10등용	1단	SS400	486*600*8*8,900	사각형	SS400 또는 STK400 또는 SPSR400	4,000*1,020*1,000 이하	용융 아연 도금	스텝볼트 포함 양카, 안정기함, 투광등기구, 램프, 안정기, 분전함, 사다리, 안전보호망 별매	포스코	한국
				2단		395*509*6*8,900							
				3단		300*414*6*8,900							

※ 1. 부속자재의 원자재는 단체표준의 인용표준을 기준합니다.

2. 상세 내용은 공통 규격서 (단체표준규격서 - 조명타워, SPC-KMIC-004-2009 : 2013, 한국금속공업협동조합 2016.8.9. 개정) 및 도면에 의합니다.

3. 노풍도 C : 높이 1.5~10m정도의 장애물이 산재해 있는 지역 또는 저층 건축물이 산재해 있는 지역

\*노풍도 C 낮은등용 기준

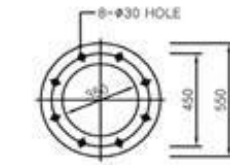
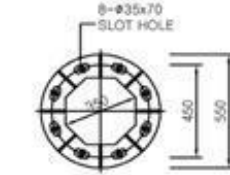
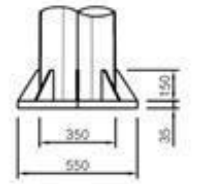
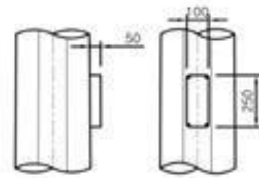
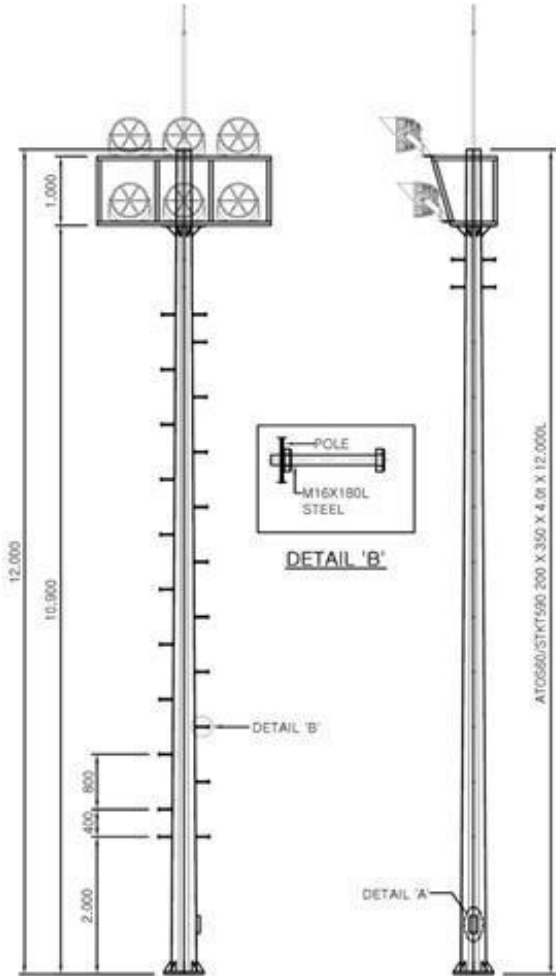
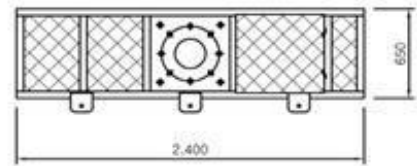
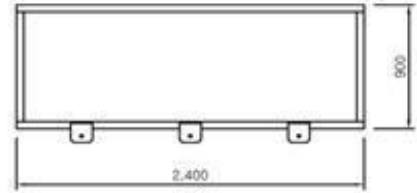
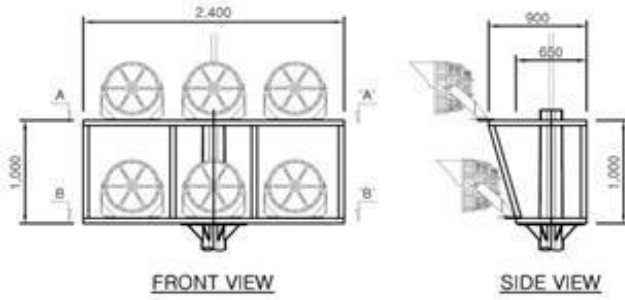

	품명:	축척: NONE SCALE	공사명:	도면명:	도면번호: T1#4-50312
	관명:	날짜: 2019. . .	다수급급자명명명명명 (MAS)	12m 노풍도A	시별번호: 22546379
	승인:				

\*노풍도 C 낮은등용 기준

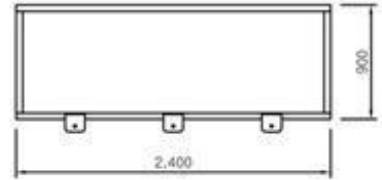
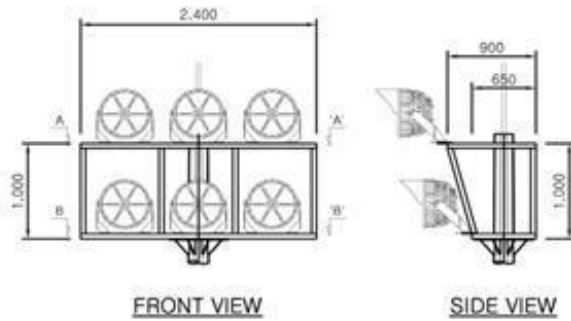

A-A' DETAIL

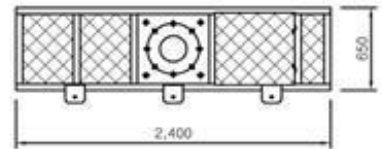

B-B' DETAIL

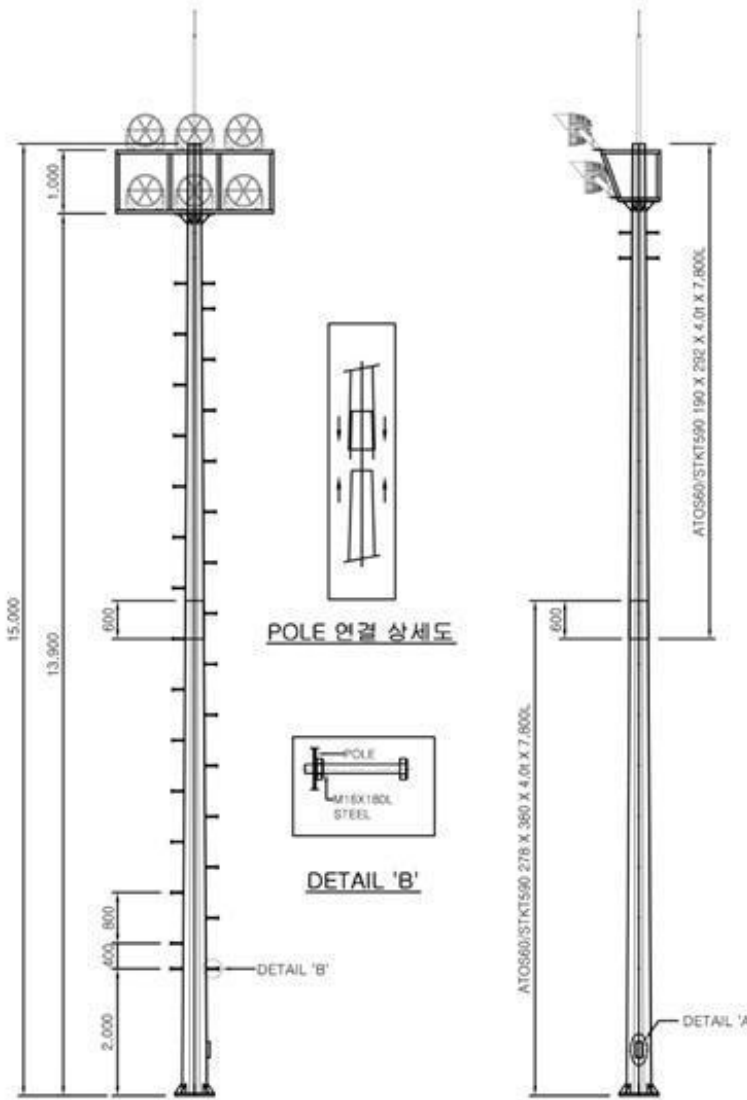

POLE 연결 상세도

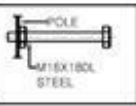

DETAIL 'B'

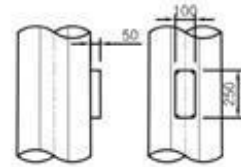

DETAIL 'A'

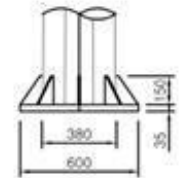

BASE PLATE DETAIL

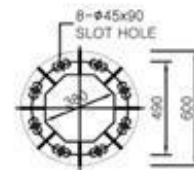

GUIDE PLATE DETAIL



제 도 :  
 규 격 :  
 출 안 :

축 척 : NONE SCALE  
 날 짜 : 2019. . .

공 사 명 : 다수급급자물품계약 (DMSS)

도 안 명 : 15m 노풍도대

도 안 번 호 : THP4-50315  
 식 별 번 호 : 22540380

• 노형도 C 및 D 적용 기준

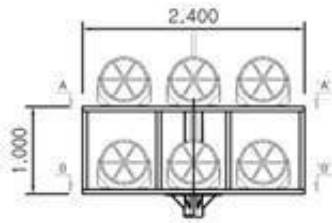

FRONT VIEW

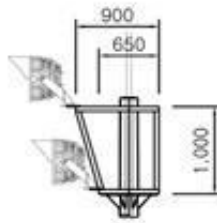

SIDE VIEW

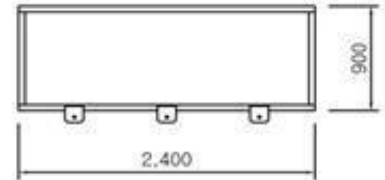

A-A' DETAIL

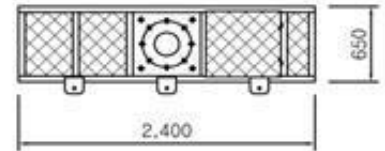

B-B' DETAIL

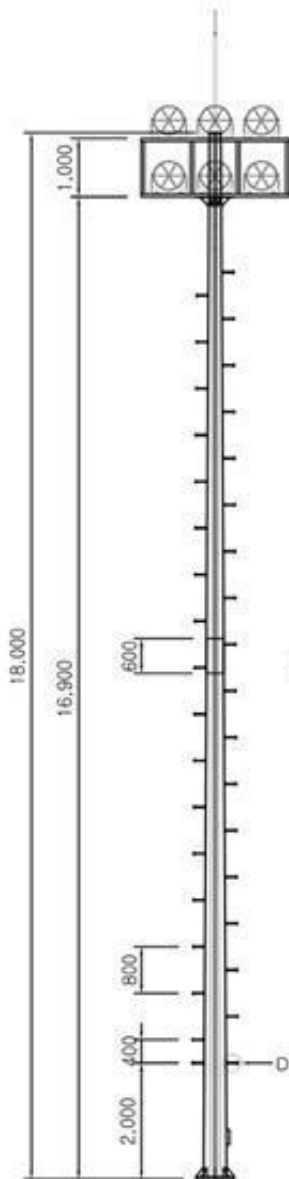

POLE 연결 상세도

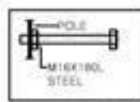

DETAIL 'B'

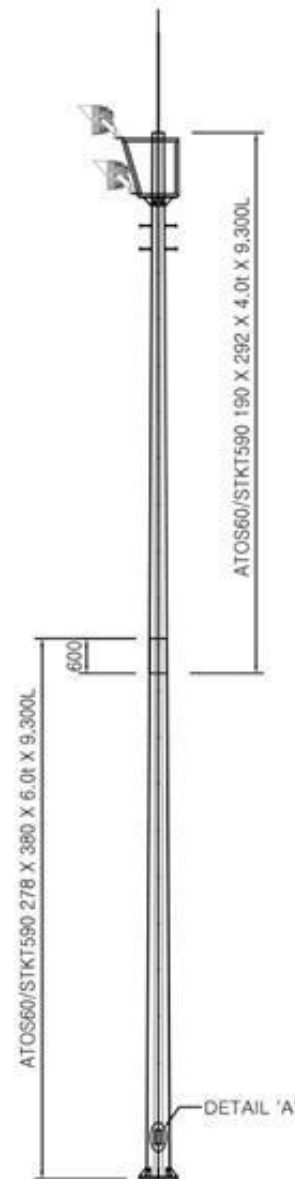

ATOS60/STKT590 278 X 380 X 6.0t X 9.300L

ATOS60/STKT590 190 X 292 X 4.0t X 9.300L

DETAIL 'A'

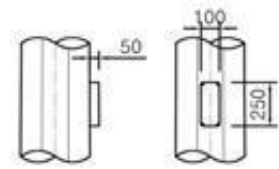

DETAIL 'A'

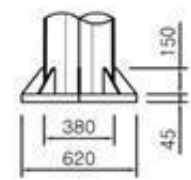

BASE PLATE DETAIL

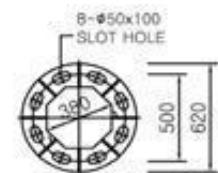

GUIDE PLATE DETAIL

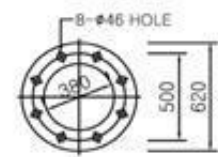

※ 본 도면은 C 단의 상세 기준

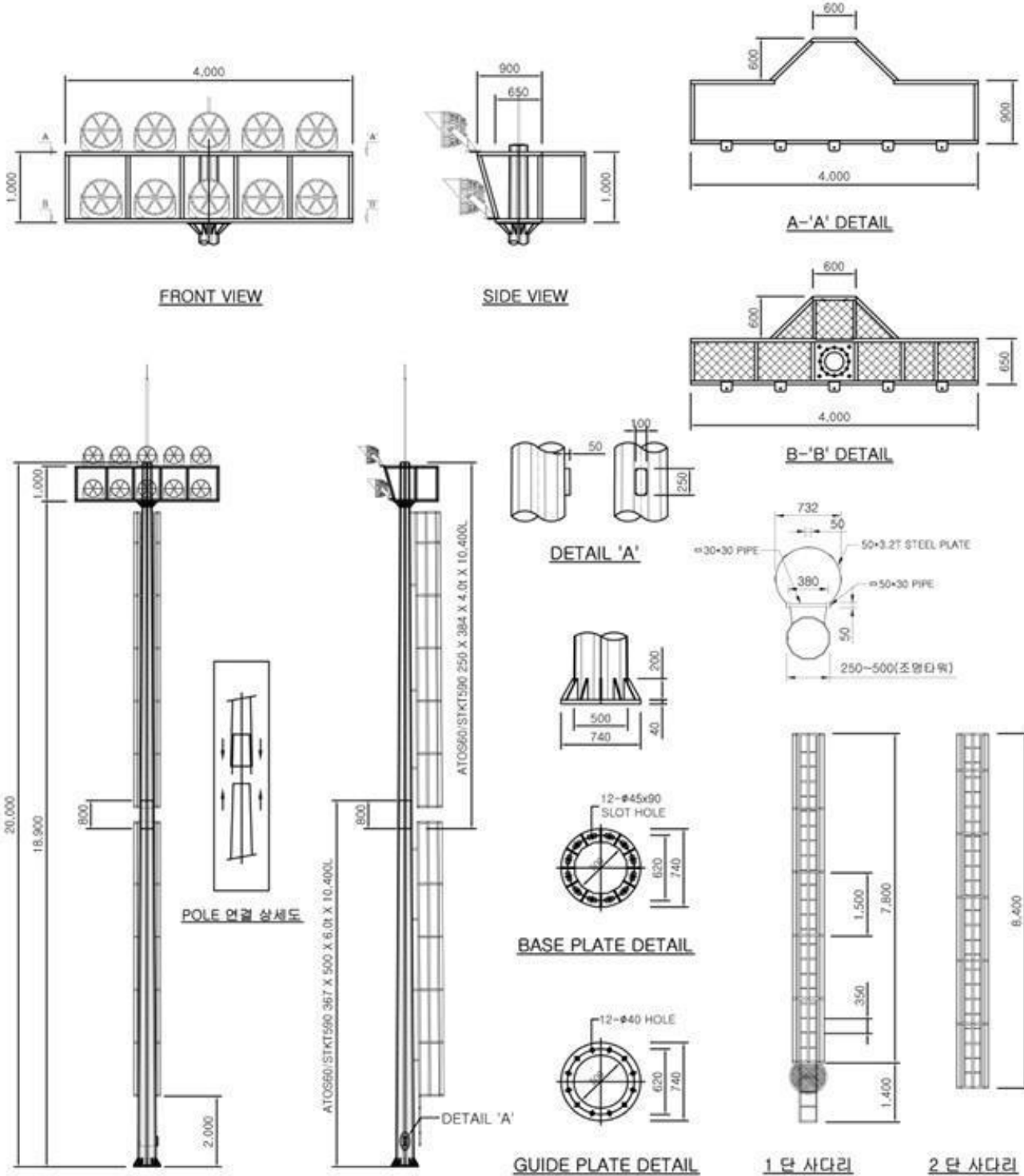

제도:	축척: NONE SCALE	회사명: 대우건설자전거사업부 (MAS)	도면명: 20m 조명타워	도면번호: THF4-50320
영도:	날짜: 2019. . . .			식별번호: 22546382

★노풍도 C 타입 적용 기준

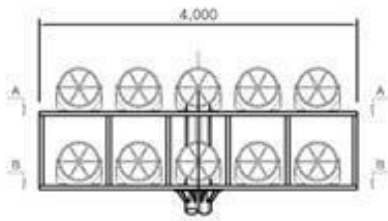

FRONT VIEW

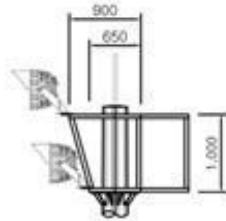

SIDE VIEW

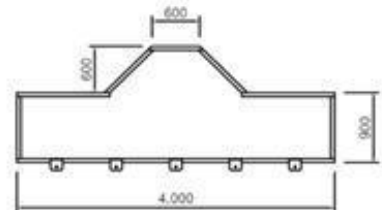

A-A' DETAIL

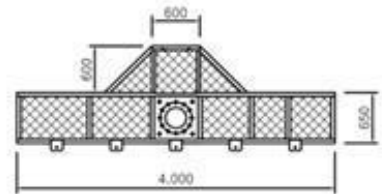

B-B' DETAIL

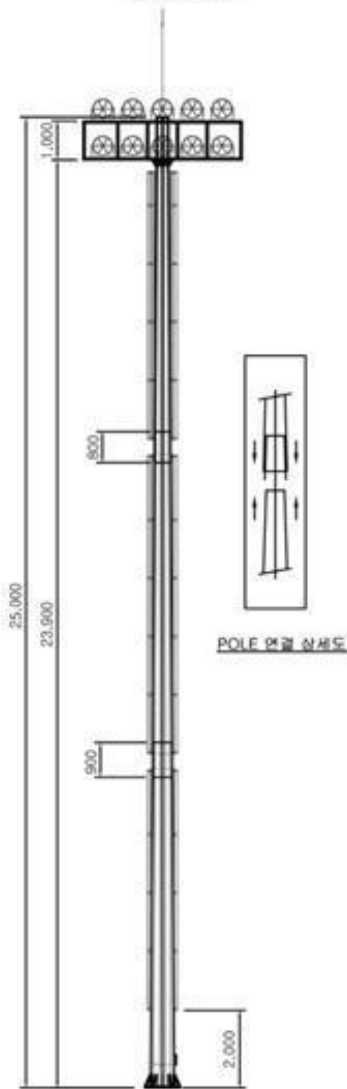

POLE 연결 상세도

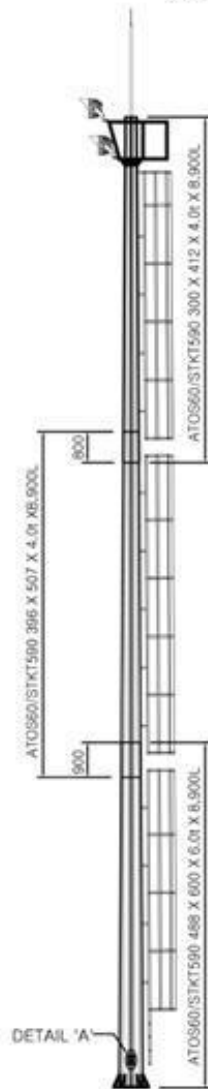

DETAIL 'A'

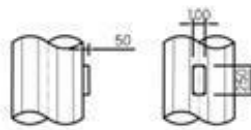

DETAIL 'A'

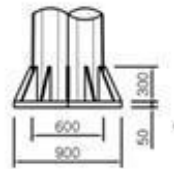

BASE PLATE DETAIL

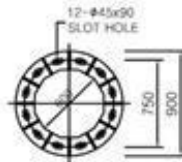

GUIDE PLATE DETAIL

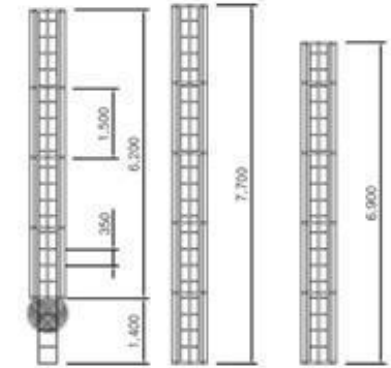
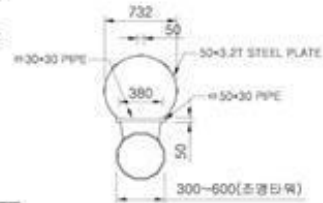
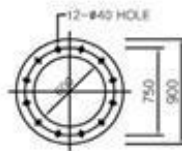

1 단 사다리 2 단 사다리 3 단 사다리



제 1 차 :  
제 2 차 :  
제 3 차 :  
제 4 차 :

척 1 : NONE SCALE  
날 1 : 2019 . . .

공 사 명 : 다수공급자발령계약 (MAS)

도 안 명 : 25m 조명타워

도 안 번 호 : THP4-S0325  
식 별 번 호 : 22546383



\*노풍도 C 낮은등용 기준

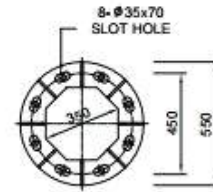
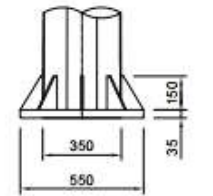
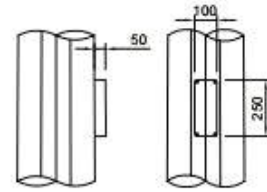
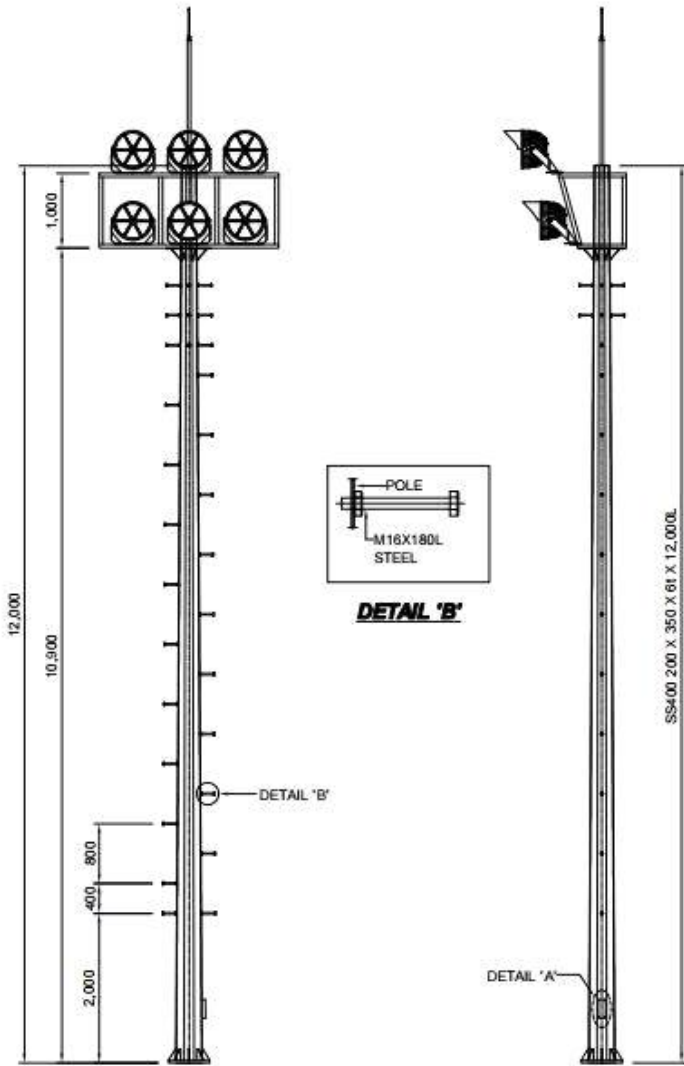
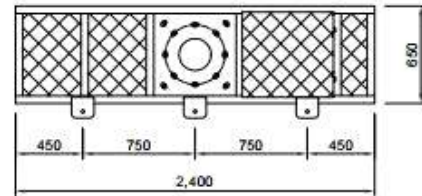
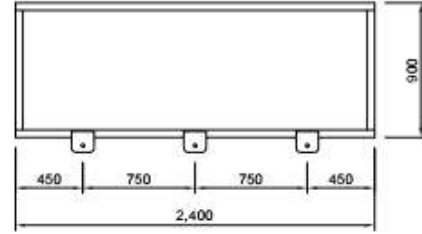
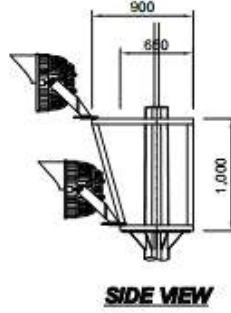
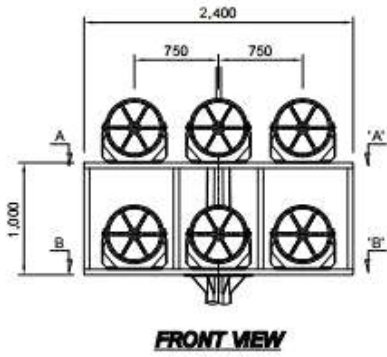

**BASE PLATE DETAIL**

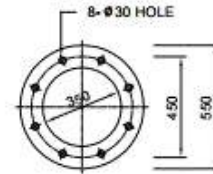

**GUIDE PLATE DETAIL**



제 도 :  
경 도 :  
승 인 :

축척: NONE SCALE  
날짜: 2020. . .

공사명: 다수공공자물품계약 (MAS)

도면명: 12m 조형단위

도면번호: THP4- S60312  
식별번호: 24076962

\*노풍도 C 낮은등용 기준

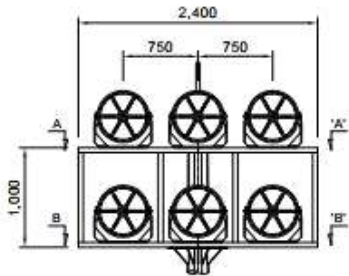

**FRONT VIEW**

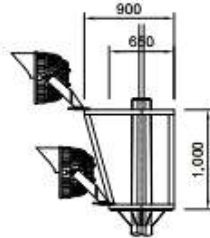

**SIDE VIEW**

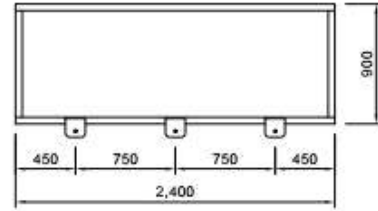

**A-'A' DETAIL**

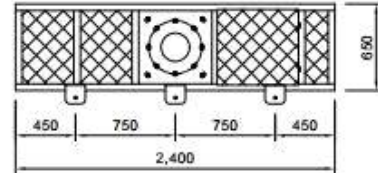

**B-'B' DETAIL**

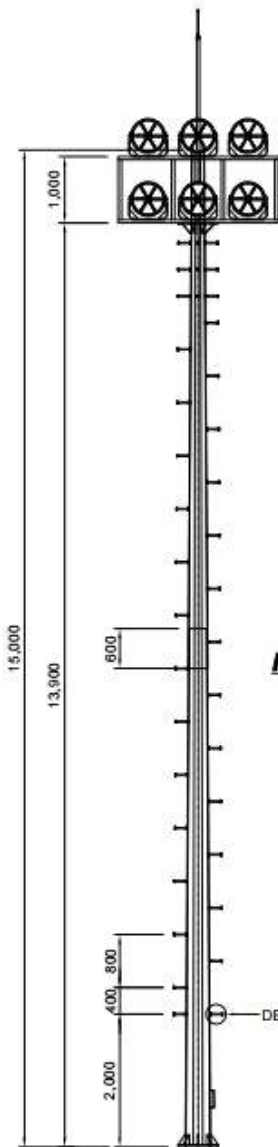

**POLE 연결 상세도**

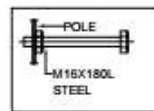

**DETAIL 'B'**

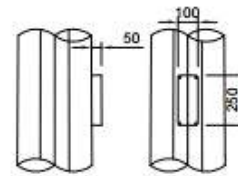
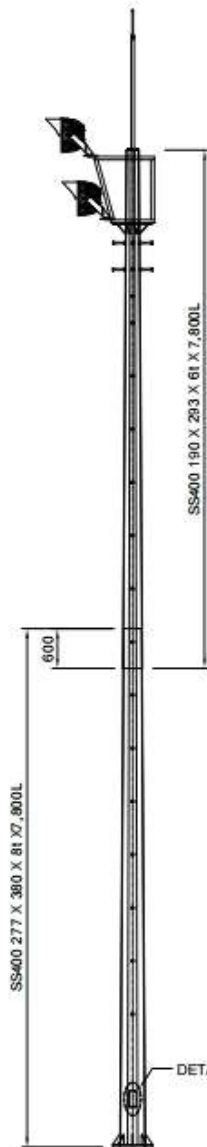

**DETAIL 'A'**

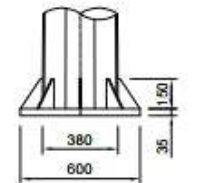

**BASE PLATE DETAIL**

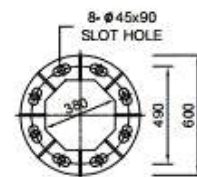

**BASE PLATE DETAIL**

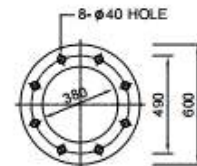

**GUIDE PLATE DETAIL**



제 도 :  
 경 도 :  
 승 인 :

축척: NONE SCALE  
 날짜: 2020. . .

공사명: 다수공공자율협력회 (MAS)

도면명: 18m 조형단위

도면번호: THP4- S60315  
 식별번호: 24076963

\*노풍도 C 낮은등용 기준

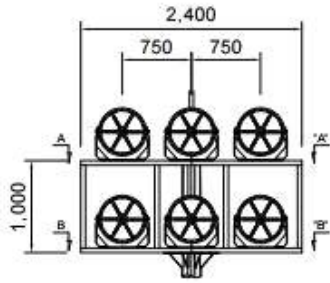

**FRONT VIEW**

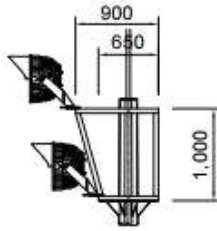

**SIDE VIEW**

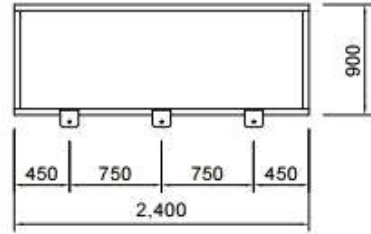

**A- 'A' DETAIL**

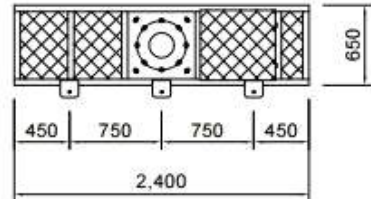

**B- 'B' DETAIL**

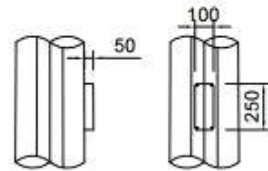

**DETAIL 'A'**

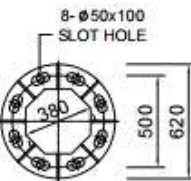
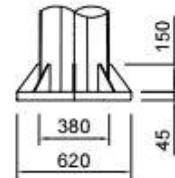

**BASE PLATE DETAIL**

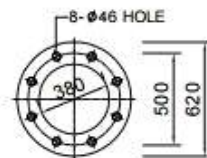

**GUIDE PLATE DETAIL**

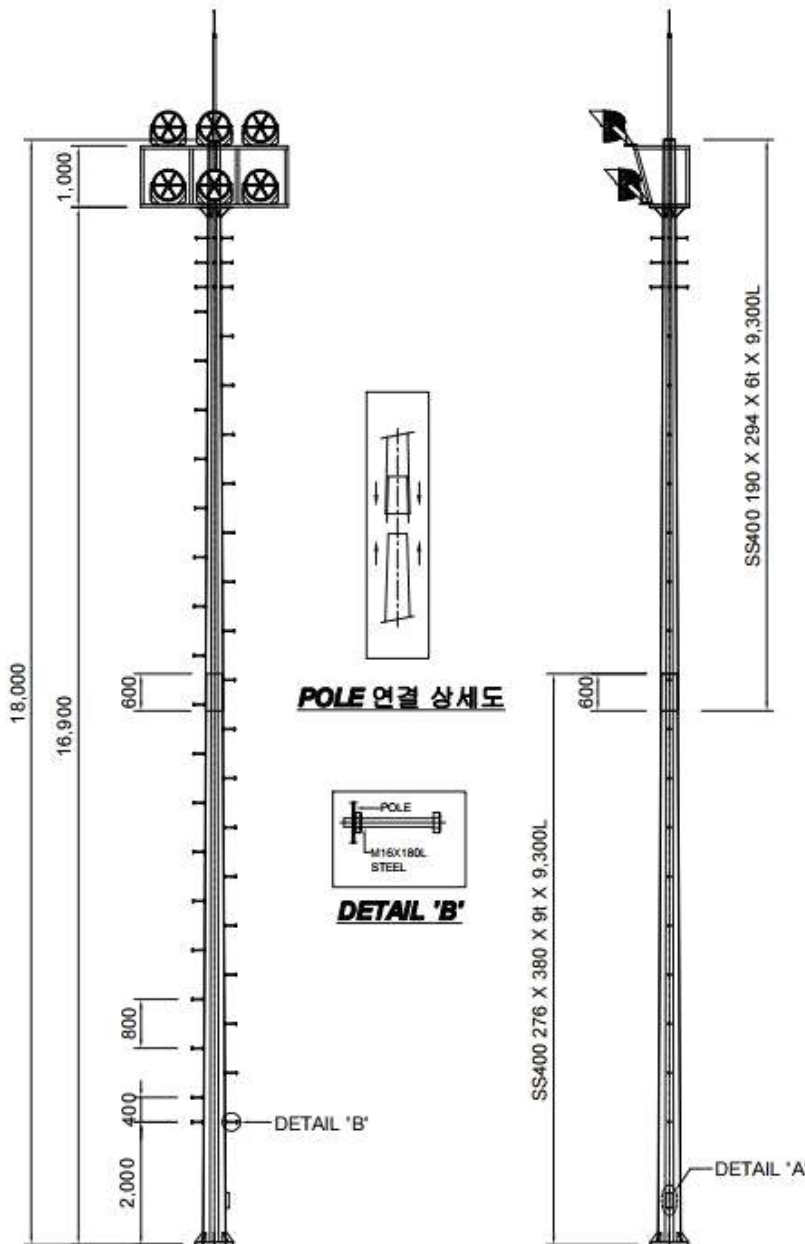

**POLE 연결 상세도**

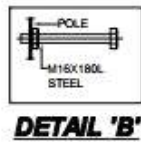

**DETAIL 'B'**

**DETAIL 'A'**



제 도 :	축척: NONE SCALE	공사명: 다수공공자물품계약 (MAS)	도면명: 18m 조형단위	도면번호: THP4-SS0318
경도:	날짜: 2020.			식별번호: 24076864
승인:				

\*노풍도 C 낮은 응용 기준

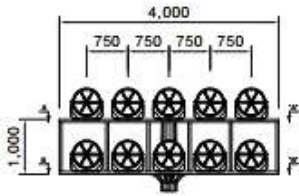

FRONT VIEW

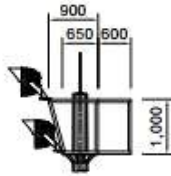

SIDE VIEW

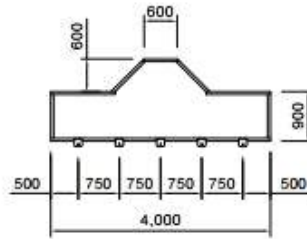

A-A DETAIL

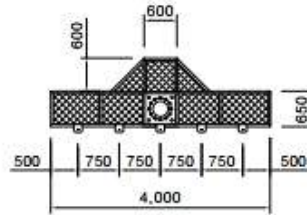

B-B DETAIL

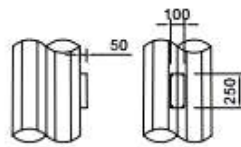
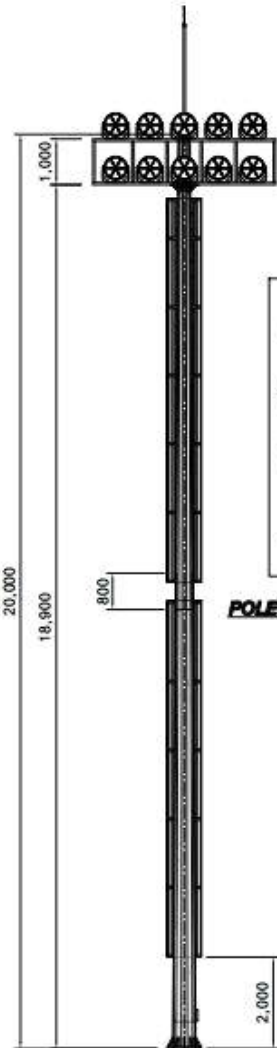
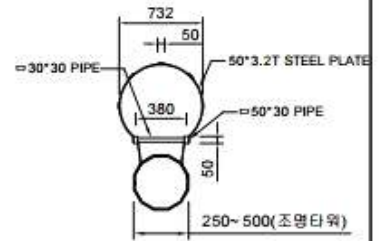

DETAIL 'A'

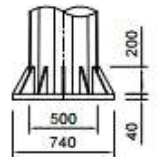

BASE PLATE DETAIL

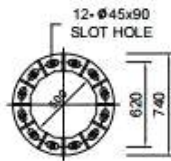

GUIDE PLATE DETAIL

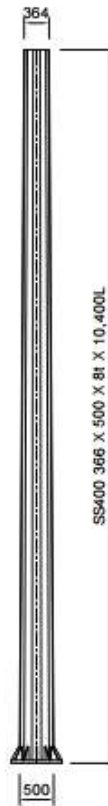
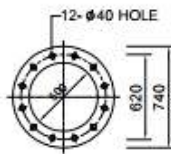

1 단 POLE



2 단 POLE 안전사다리 DETAIL

\*사다리의 전체 길이는 제작 시 조금씩 변동될 수 있음.



제도 :  
 검토 :  
 승인 :

축척: NONE SCALE  
 날짜: 2019.

공시명: 다수공급자물품계약 (MAS)

도면명: 20m 조명타워

도면번호: THP4-S50320  
 식별번호: 24076865

\*노면도 C 낮기 평형 기준

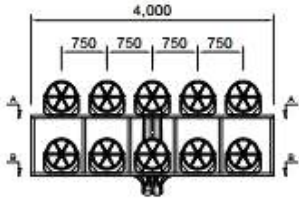

FRONT VIEW

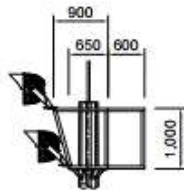

SIDE VIEW

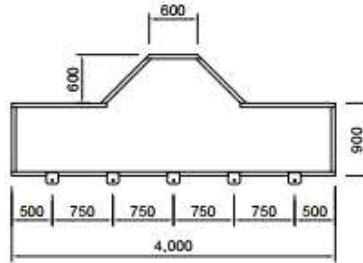

A-A' DETAIL

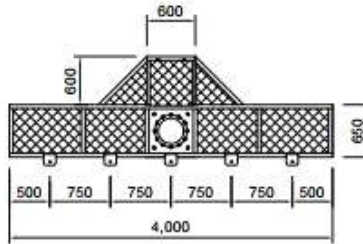

B-B' DETAIL

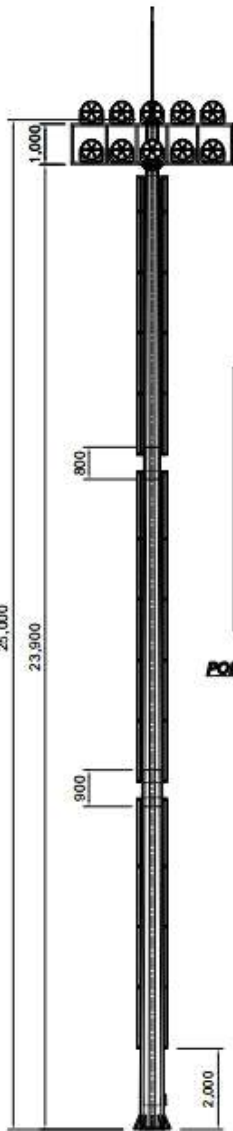
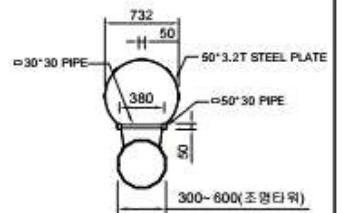

POLE 전체 상세도

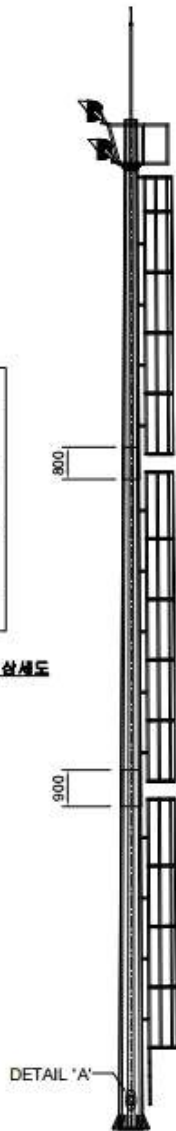

DETAIL 'A'

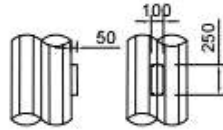

DETAIL 'A'

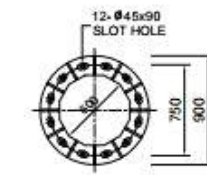
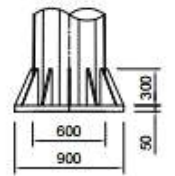

BASE PLATE DETAIL

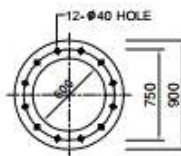

GUIDE PLATE DETAIL

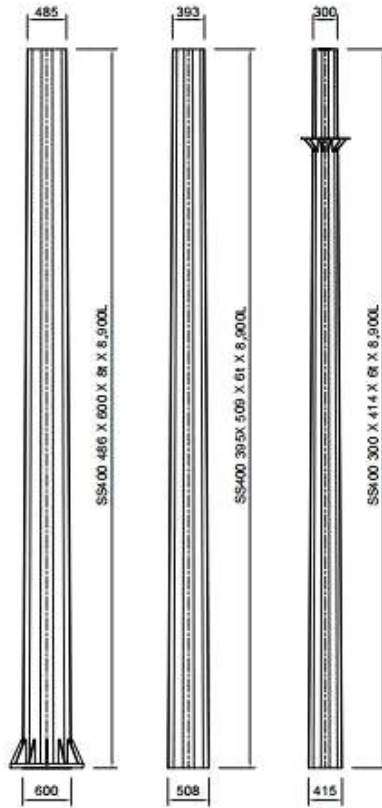

1단 POLE 2단 POLE 3단 POLE

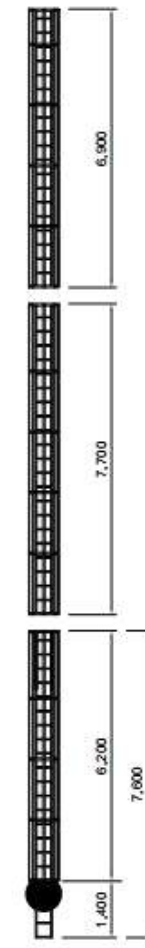

안전사다리 DETAIL

\*사다리의 전체 길이는 제작 시 조금씩 변동될 수 있음.



제도 :  
 검토 :  
 승인 :

축척 : NONE SCALE  
 날짜 : 2019. . .

공사명 : 다수공공자물용계약 (MAS)

도면명 : 20m 조명단위

도면번호 : THP4-S50325  
 식별번호 : 24076866

\* 노면도 C 낮고 평형 기준

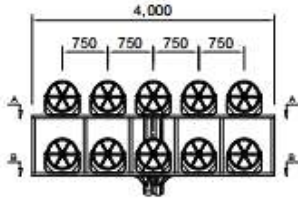

FRONT VIEW

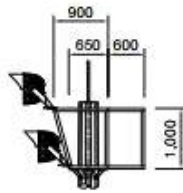

SIDE VIEW

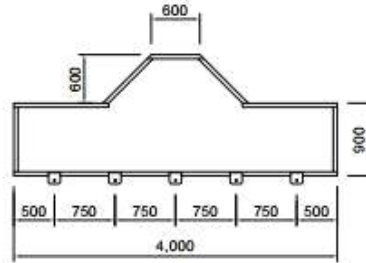

A-A' DETAIL

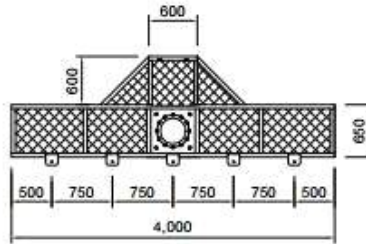

B-B' DETAIL

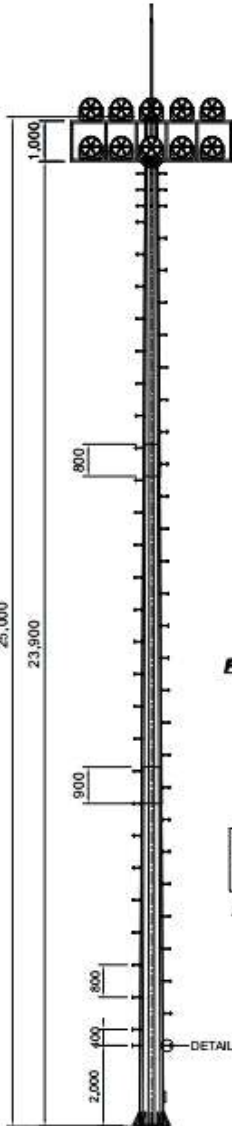

POLE TOP

DETAIL 'B'

DETAIL 'A'

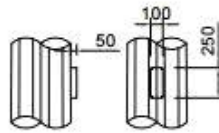

DETAIL 'A'

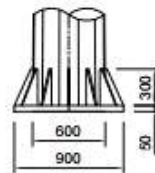

BASE PLATE DETAIL

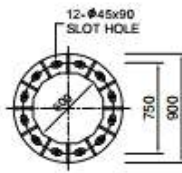

GUIDE PLATE DETAIL

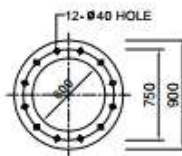

1 단 POLE



2 단 POLE

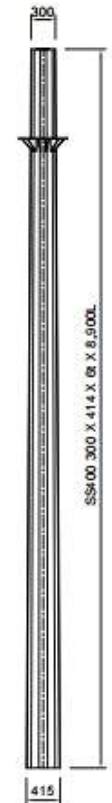

3 단 POLE



제 도 :  
 규 모 :  
 승 인 :

축척: NONE SCALE  
 날짜: 2019. . .

공사명: 다수공공자물품계약 (MAS)

도면명: 20m 조명대형

도면번호: THP4-SS50325  
 식별번호: 24082253